

Installation Instructions

PA-2432-RT/PA-4835-RT/PA-6032-RT
PA-7032-RT/PA-8540-RT/PA-10045-RT

SUGGESTED TOOLS AND MATERIALS

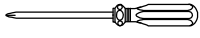

Screwdriver

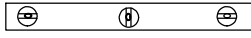

Level



Drill



Tape Measure

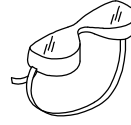

Safety Glasses



Pencil

PARTS & HAREWARE INCLUDED



Anchor 6x



Screw 6x

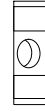

Level 1x

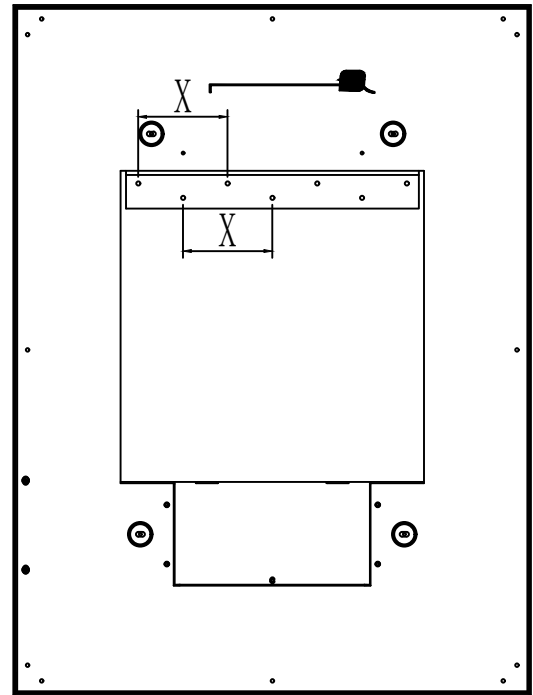
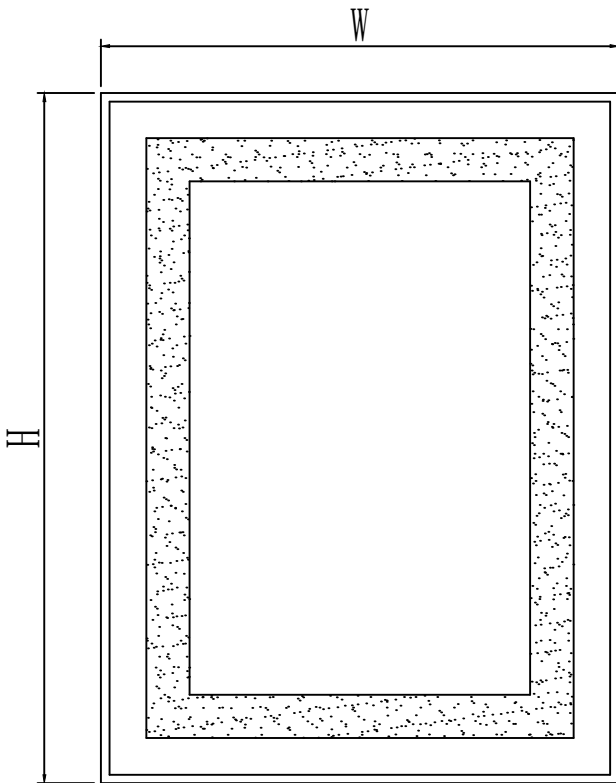

Installation Instructions

PA-2432-RT/PA-4835-RT/PA-6032-RT
PA-7032-RT/PA-8540-RT/PA-10045-RT

SUGGESTED TOOLS AND MATERIALS

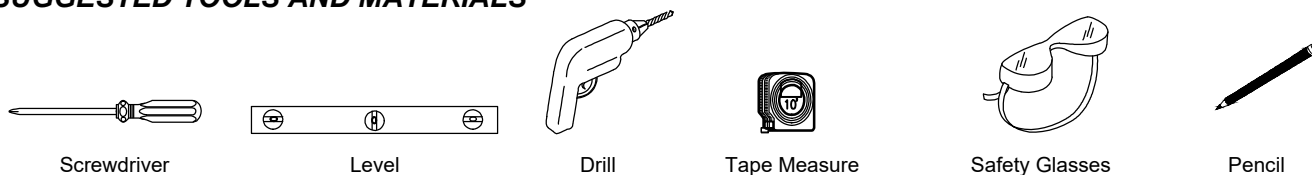

PARTS & HAREWARE INCLUDED



INSTALLATION INSTRUCTIONS

①

1->Detach the cleat from the mirror.
2->Level the hanging cleat with a level ruler and mark the installation hole position of the hanging cleat with a pencil.
3->Drill holes.

②

Insert the anchors into the wall(Use at least 5 anchors).

③

Install the hanging cleat into the wall.
Use 5x45mm screws to hanging cleat to wall(Use at least 5 screws).

④

Wiring from light fitting

Neutral Wire	⊖	⊖	white(N)
Earth(green/yellow)	⊖	⊖	Green/yellow
Live Wire	⊖	⊖	black(L)

⑤

Hang the mirror onto the wall.

Wall Wall

DETAIL A